



FOLLOW THE  
**GMG NATION**



[GREENMOUNTAINGRILLS.COM](http://GREENMOUNTAINGRILLS.COM)



**GMG**  
GREEN MOUNTAIN GRILLS

# OWNER'S MANUAL

PEAK PRIME™ 2.0

PLEASE READ AND FOLLOW ALL ASSEMBLY INSTRUCTIONS, SAFETY INFORMATION,  
AND OPERATING INSTRUCTIONS OF THIS MANUAL BEFORE INITIAL START UP.

# IMPORTANT SAFETY INFO

**PLEASE READ, UNDERSTAND, AND FOLLOW ALL DIRECTIONS IN THIS MANUAL BEFORE OPERATING YOUR GRILL.**

## GENERAL WARNINGS

- THIS IS AN ELECTRIC APPLIANCE. OBSERVE ALL NORMAL SAFETY PROCEDURES FOR A HIGH VOLTAGE APPARATUS.
- FOR OUTDOOR USE ONLY.
- DO NOT USE IN ANY ENCLOSED AREA OR ANY AREA WITHOUT ADEQUATE VENTILATION.
- DO NOT MODIFY THIS GRILL IN ANY MANNER NOT IN ACCORDANCE WITH MANUFACTURER GUIDELINES.
- DO NOT OPERATE THIS GRILL OTHER THAN AS SPECIFIED IN THIS MANUAL.
- BE AWARE OF AND RESPOND TO THE INHERENT DANGER OF ANY APPLIANCE THAT PRODUCES FLAMES.
- DO NOT USE THE GRILL IN RAIN OR AROUND ANY WATER SOURCE SUCH AS SPRINKLERS.
- DO NOT STORE OR USE COMBUSTIBLE MATERIALS NEAR THIS GRILL.
- DO NOT PUT A BARBECUE COVER OR ANYTHING FLAMMABLE ON OR UNDER THE GRILL WHILE IN USE.
- YOU MUST CONTACT YOUR LOCAL HOMEOWNERS' ASSOCIATION, BUILDING, FIRE OFFICIALS, OR OTHER AUTHORITY HAVING JURISDICTION, TO OBTAIN THE NECESSARY PERMITS, PERMISSION OR INFORMATION ON ANY INSTALLATION RESTRICTIONS, SUCH AS ANY GRILL BEING INSTALLED ON A COMBUSTIBLE SURFACE, INSPECTION REQUIREMENTS, OR EVEN THE ABILITY TO OWN AND OPERATE SUCH A GRILL IN YOUR AREA.
- THE BACK AND SIDES OF THE GRILL MUST BE AT LEAST 36 IN. (914.4 MM) FROM ANY COMBUSTIBLES, AND THERE MUST BE AT LEAST 48 IN. (1219.2 MM) OF CLEARANCE BETWEEN THE TOP OF THE CHIMNEY CAP AND ANY COMBUSTIBLE MATERIALS ABOVE THE GRILL.

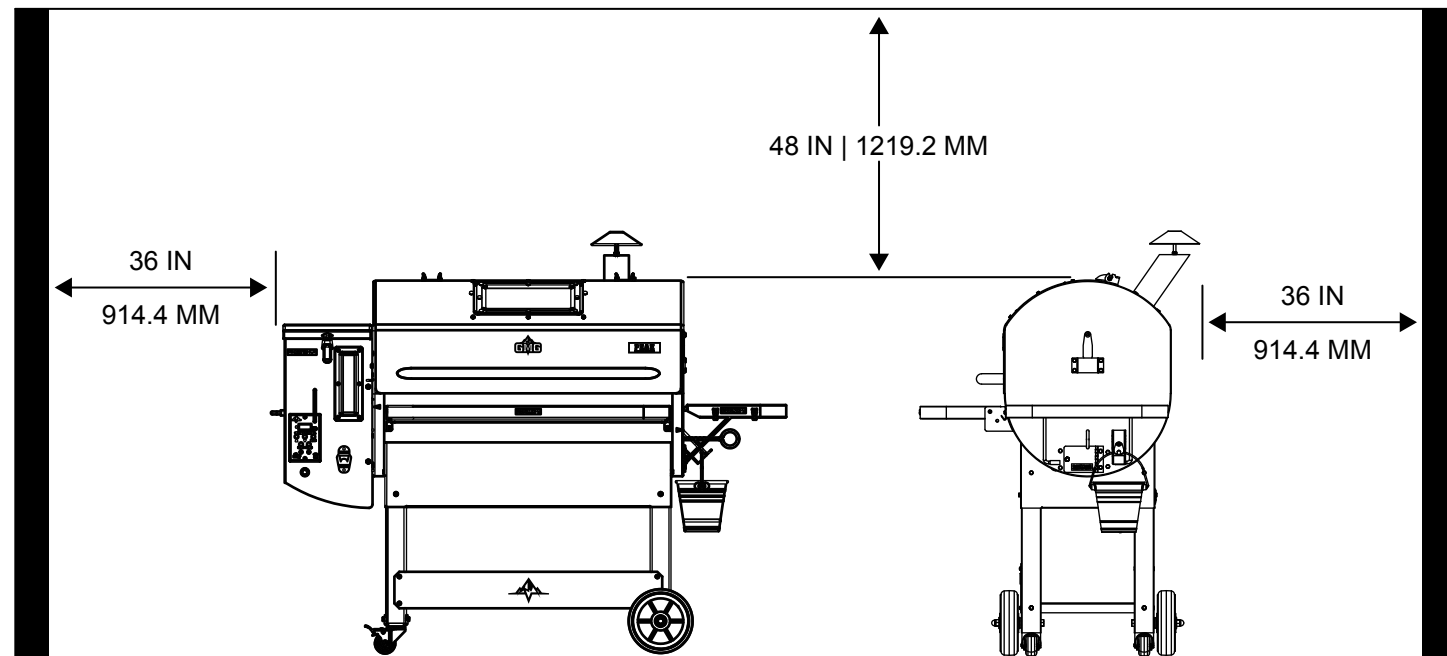

- DO NOT ALLOW WATER TO ENTER THE PELLET HOPPER. PELLETS EXPOSED TO WATER TURN INTO SAWDUST THAT THE AUGER FEED SYSTEM WILL NOT DELIVER TO THE FIREBOX.
- AFTER A PERIOD OF STORAGE OR NONUSE, THE GRILL SHOULD BE CHECKED FOR AUGER AND BURN POT OBSTRUCTIONS, FOREIGN OBJECTS INSIDE BOTH THE GRILL AND THE HOPPER, AND AIR BLOCKAGE, BEFORE USE, IN ACCORDANCE WITH THE CORRECT PROCEDURES SET FORTH IN THIS MANUAL.
- DO NOT OPERATE THE GRILL WHILE TRANSPORTING IT! THE GRILL MUST ALWAYS BE STATIONARY WHEN IT IS ON. MAKE CERTAIN THAT THE GRILL IS COLD AND ALL FIRE IN THE FIREBOX IS EXTINGUISHED BEFORE MOVING IT.

## WOOD PELLET AND OTHER FUEL RESTRICTIONS

- THIS GRILL IS DESIGNED TO BURN ONLY FOOD-SAFE HARDWOOD PELLETS. DO NOT USE ANY OTHER TYPE OF FUEL.
- DO NOT USE ANY PELLETS LABELED AS HAVING ADDITIVES OR DESIGNED FOR USE IN HOME HEATING SYSTEMS.
- DO NOT USE SOFTWOOD PELLETS. THE SMOKE CONTAINS DANGEROUS PHENOLS THAT YOU DO NOT WANT TO INGEST.
- DO NOT USE HEATING PELLETS, AS THEY MAY CONTAIN UNSAFE IMPURITIES THAT COULD HARM YOUR HEALTH OR YOUR GRILL.
- GMG'S GRILLS ARE DESIGNED FOR AND TESTED WITH GREEN MOUNTAIN GRILL'S BRAND OF PELLETS. WHILE YOU MAY USE OTHER BRANDS OF PELLETS, WE DO NOT WARRANT THAT THE GRILL WILL PERFORM AT THE SAME LEVEL.
- NEVER USE LAVA ROCK, NON-PELLETIZED WOOD, OR CHARCOAL IN THE GRILL.
- DO NOT USE ANY GASOLINE, LANTERN FUEL, WHITE GAS, DIESEL FUEL, PETROL, LIGHTER FLUID, CHARCOAL LIGHTER, ALCOHOL GEL, OR ANY OTHER FUEL OR ACCELERANTS FOR LIGHTING OR RELIGHTING THE GRILL.

## OPERATING PRECAUTIONS

- THIS GRILL MUST NOT BE USED BY PERSONS WITH REDUCED PHYSICAL, SENSORY OR MENTAL CAPABILITIES, OR LACK OF EXPERIENCE AND KNOWLEDGE, UNLESS THEY HAVE BEEN GIVEN SUPERVISION OR INSTRUCTION CONCERNING THE USE OF THE APPLIANCE BY A PERSON RESPONSIBLE FOR THEIR SAFETY AND ARE BEING SUPERVISED BY A RESPONSIBLE ADULT.
- CHILDREN SHOULD NEVER USE THE GRILL.
- IF YOUR GRILL DOES NOT IGNITE, MAKE CERTAIN TO TURN OFF THE UNIT AND REMOVE THE GREASE TRAY AND THE HEATSHIELD TO CHECK THE FIREBOX. BEFORE YOU RESTART, YOU MUST MAKE CERTAIN THAT THE FIREBOX IS CLEAN.
- ACCESSIBLE PARTS OF THE GRILL WILL BE VERY HOT, AND YOUNG CHILDREN AND PETS MUST BE KEPT AWAY FROM THE GRILL WHILE IT IS IN USE.
- NEVER LEAN OVER AN OPEN GRILL OR PLACE HANDS OR FINGERS ON THE FRONT EDGE OF THE GRILL OR IN THE PELLET HOPPER.
- DO NOT USE ACCESSORIES NOT DESIGNED FOR USE WITH THIS GRILL.

- USE HEAT RESISTANT BARBECUE MITTS OR GLOVES WHILE OPERATING THE GRILL.
- DO NOT TRANSPORT THE GRILL WHILE OPERATING OR WHILE THE GRILL IS HOT. MAKE SURE THAT THE FIRE IS COMPLETELY OUT AND THE GRILL IS COMPLETELY COOL TO THE TOUCH BEFORE MOVING IT.
- ASHES SHOULD BE PLACED IN A METAL CONTAINER WITH A TIGHT-FITTING LID, AND THE CONTAINER MUST BE PLACED ON A NONCOMBUSTIBLE FLOOR OR ON THE GROUND, WELL AWAY FROM ALL COMBUSTIBLE MATERIALS. ASHES SHOULD BE RETAINED IN THE CONTAINER UNTIL ALL CINDERS HAVE THOROUGHLY COOLED BEFORE FURTHER DISPOSAL.

## REMOTE/WIFI SMART CONTROL APP USAGE

- IF USING A REMOTE CONTROL OR THE REMOTE CELL PHONE APPLICATION TO CONTROL THE OPERATION OF THE GRILL, YOU MUST FIRST MAKE SURE THAT ALL SAFETY PRECAUTIONS OTHERWISE APPLICABLE TO THE OPERATION OF THE GRILL HAVE BEEN OBSERVED PRIOR TO STARTING THE GRILL. MOREOVER, A RESPONSIBLE ADULT FAMILIAR WITH THE OPERATION OF THE GRILL SHOULD BE AT ALL TIMES ABLE TO VIEW THE GRILL, AND IS IN CLOSE-ENOUGH PROXIMITY TO THE GRILL TO BE ABLE TO ADDRESS ANY EMERGENCY CONDITIONS, BEFORE OPERATING THE GRILL REMOTELY.

## MAINTENANCE ISSUES

- THE GRILL MUST BE CLEANED AND MAINTAINED REGULARLY IN ACCORDANCE WITH THE INSTRUCTIONS SET FORTH IN THIS MANUAL.
- DO NOT MODIFY OR REMOVE ANY OF THE PARTS OF THE GRILL.
- ALWAYS UNPLUG THE GRILL BEFORE PERFORMING ANY SERVICE OR MAINTENANCE.
- NEVER ADD PELLETS BY HAND TO THE FIREPOT WHILE THE GRILL IS RUNNING. IF THE GRILL RUNS OUT OF PELLETS DURING COOKING, LET THE GRILL COMPLETELY COOL AND START AGAIN FOLLOWING THE INITIAL START-UP INSTRUCTIONS.
- ALWAYS BE SURE TO INSTALL THE HEAT SHIELD PROPERLY, IN ACCORDANCE WITH THE INSTRUCTIONS ELSEWHERE IN THIS MANUAL, TO REDUCE RISK OF A GREASE FIRE.
- GREASE FIRES ARE OFTEN CAUSED BY FAILING TO PROPERLY MAINTAIN THE GRILL BY CLEANING THE GREASE TRAY AND THE GREASE DRAIN CONSISTENTLY. IF A GREASE FIRE OCCURS, TURN THE CONTROL UNIT TO “OFF,” AND LEAVE THE LID CLOSED UNTIL THE FIRE IS OUT. DO NOT UNPLUG THE POWER CORD. IF AN UNCONTROLLED FIRE DOES OCCUR, IMMEDIATELY CALL THE LOCAL FIRE DEPARTMENT. NEVER PUT WATER ON THE FIRE.
- MAKE ABSOLUTELY CERTAIN THE GRILL AND ASHES ARE COLD BEFORE ACCESSING THE INTERIOR. DO NOT REMOVE HOT ASH FROM THE GRILL, AS IT MAY CAUSE A FIRE ELSEWHERE.

## CREOSOTE

- OVER TIME, A LAYER OF TAR-LIKE SOOT OR CREOSOTE MAY FORM INSIDE YOUR GRILL. YOU SHOULD REGULARLY REMOVE SUCH SUBSTANCES FROM INSIDE YOUR GRILL, AS A CREOSOTE FIRE CAN BURN OUT OF CONTROL.
- DARK AND SOOTY SMOKE MAY INDICATE THE PRESENCE OF A CREOSOTE BUILDUP INSIDE YOUR GRILL. IF YOU NOTICE THIS, TURN OFF THE GRILL AND WAIT FOR IT TO COOL COMPLETELY. THEN, REMOVE ANY COLD CREOSOTE FROM THE GRILL WITH A TOWEL.
- SHOULD A CREOSOTE FIRE OCCUR, TURN THE CONTROL UNIT TO “OFF,” AND LEAVE THE LID CLOSED UNTIL THE FIRE IS OUT. DO NOT UNPLUG THE POWER CORD. DO NOT TRY TO REMOVE THE GRILL, TRY TO SMOTHER THE FIRE, OR PUT WATER ON THE FIRE. IF AN UNCONTROLLED FIRE DOES OCCUR, IMMEDIATELY CALL THE FIRE DEPARTMENT.

## CARBON MONOXIDE WARNING

- THE GRILL MUST BE OPERATED AT ALL TIMES IN ACCORDANCE WITH THESE GUIDELINES TO PREVENT CARBON MONOXIDE FROM POISONING YOU, YOUR FAMILY, OR OTHERS.
- CARBON MONOXIDE IS COLORLESS AND ODORLESS, SO IT IS IMPORTANT TO OPERATE THE GRILL IN STRICT ACCORDANCE WITH THIS OPERATING MANUAL, AND THESE WARNINGS.
- THE GRILL MUST AT ALL TIMES BE OPERATED OUTSIDE, IN A WELL-VENTILATED AREA, AND IN STRICT ACCORDANCE WITH ALL OTHER INSTRUCTIONS IN THIS MANUAL TO AVOID CARBON MONOXIDE POISONING.
- THE SYMPTOMS OF CARBON MONOXIDE POISONING INCLUDE HEADACHES, DIZZINESS, WEAKNESS, NAUSEA, VOMITING, SLEEPINESS, AND CONFUSION. CARBON MONOXIDE REDUCES THE BLOOD'S ABILITY TO CARRY OXYGEN, AND LOW BLOOD OXYGEN LEVELS CAN RESULT IN LOSS OF CONSCIOUSNESS AND DEATH.
- ALCOHOL CONSUMPTION AND DRUG USE INCREASE THE EFFECTS OF CARBON MONOXIDE POISONING.
- CARBON MONOXIDE IS ESPECIALLY TOXIC TO MOTHERS AND CHILDREN DURING PREGNANCY, INFANTS, THE ELDERLY, SMOKERS, AND PEOPLE WITH BLOOD OR CIRCULATORY SYSTEM PROBLEMS, SUCH AS ANEMIA OR HEART DISEASE.
- YOU MUST SEE A DOCTOR IF YOU DEVELOP EITHER COLD OR FLU-LIKE SYMPTOMS WHILE COOKING IN THE VICINITY OF THE GRILL, AS CARBON MONOXIDE POISONING CAN EASILY BE MISTAKEN FOR A COLD OR FLU AND IS OFTEN DETECTED TOO LATE.

## PROP 65 - STATE OF CALIFORNIA



### WARNING

THIS PRODUCT CAN EXPOSE YOU TO CHEMICALS INCLUDING CHROMIUM (HEXAVALENT COMPOUNDS) AND CARBON DIOXIDE, WHICH ARE KNOWN TO THE STATE OF CALIFORNIA TO CAUSE BIRTH DEFECTS OR OTHER REPRODUCTIVE HARM, AND CAN EXPOSE YOU TO WOOD DUST, WHICH IS KNOWN TO THE STATE OF CALIFORNIA TO CAUSE CANCER. FOR MORE INFORMATION, GO TO [WWW.P65WARNINGS.CA.GOV](http://WWW.P65WARNINGS.CA.GOV).



# WELCOME TO THE GMG NATION

FOLLOW THE  
WOOD-FIRED REVOLUTION



#GMG #GMGNation

## TABLE OF CONTENTS

SAFETY INFO	1
GMG WOOD PELLETS	7
PELLET GRILL ATTACHMENTS	8
GRILL FEATURES	9
DIGITAL CONTROLLER	10
PREFIRE CHECK	11
OPERATING YOUR GRILL	12
UNDERSTANDING YOUR GRILL	14
MAINTAINING YOUR GRILL	16
WOOD-FIRED 101	17
GENERAL OPERATING TIPS	18
TROUBLESHOOTING	20
SUPPORT	23
WARRANTY	24



# GMG HARDWOOD

GREEN MOUNTAIN GRILLS BRAND PELLETS ARE MADE OF 100% KILN-DRIED SAWDUST THAT NEVER TOUCHES THE FLOOR. OUR PELLETS ARE HELD TOGETHER BY THE NATURAL LIGNINS IN THE WOOD AND ARE A LARGER DIAMETER PELLET THAT ALLOWS THEM TO LAST LONGER THAN STANDARD SIZE PELLETS.



Side**BURN**™



**RACK**™ **SYSTEM**



GMG IS CHANGING THE GAME OF BACKYARD  
**VERSATILITY & CUSTOMIZATION**

**WOOD-FIRED PIZZA**



**BBQ ROTISSERIE**





# PEAK PRIME™ 2.0

## GRILL FEATURES



### 12V DIRECT POWER

With AC/DC dual connectivity, you can connect the grill with either a 110V/220V or 12V plug but the grill ultimately runs off 12V direct current. This is a much safer and optimized power source that allows for our micro-adjusted variable speed fan and auger motor for more precise temp control, greater pellet fuel economy, and less waste.

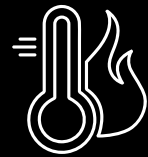

### VERSATILE TEMP RANGE

From 150° - 550°F you can smoke a 16 hour brisket low and slow or crank up the heat for a beautiful sear on your steak. GMG wood-fired versatility is unmatched.



### WIFI SMART CONTROL

Control and monitor your grill and internal meat temps right from your phone through your local WiFi network with the GMG App.



### RACKT™ SYSTEM

Enabled with GMG RACKT™, a rack technology system that allows for easy attachable elevated racks, smoke shelves, and cooking pans. RACKT™ system and accessories sold separately.

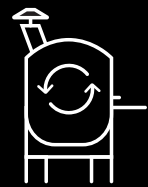

### REDESIGNED CHAMBER

The new rounded/peaked hybrid chamber design provides for optimal heat distribution and smoke circulation creating a superior 360° of wood-fired greatness. The elevated lid design allows for additional height inside the grilling chamber for larger cooks and maximum wood flavor.

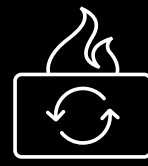

### VENTURI-STYLE

The Venturi-Style design is lined with vertical vents creating a burn pot cyclone of airflow for maximum heat distribution.

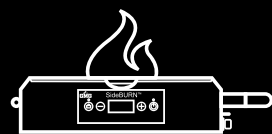

### SideBURN™

Enabled for the SideBURN™ attachment, the ultimate sous chef giving you quick, high-heat infrared searing capabilities, and a secondary cooking surface with fine tune adjusting.



### WOOD-FIRED PIZZA

Pizza night at home will never be the same after cooking artisan wood-fired pizzas right in your back yard. This thing is a game changer! Pizza attachment sold separately.



### BBQ ROTISSERIE

Enabled with built-in rotisserie mount brackets, you can easily install our wood-fired rotisserie for some of the juiciest and most flavorful smokes. Rotisserie attachment sold separately.

# DIGITAL CONTROLLER

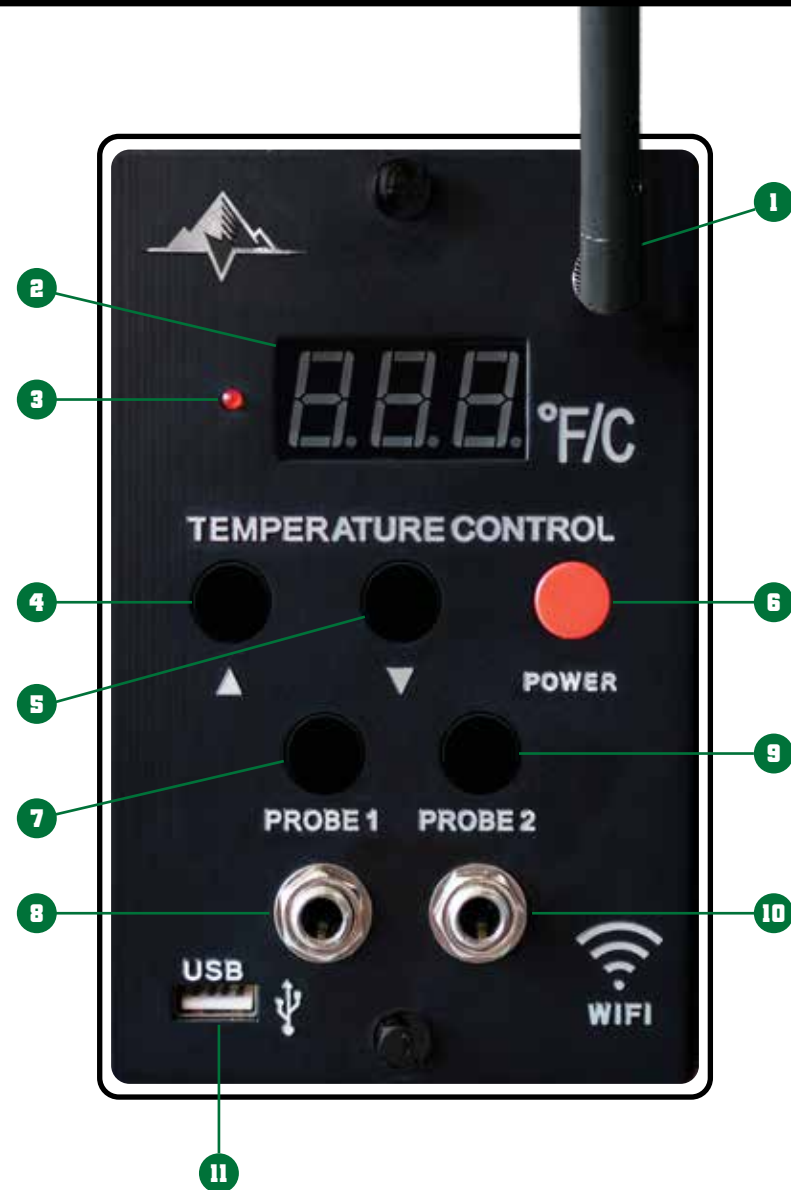

#	DESCRIPTION
1	Antenna Connection
2	Digital Readout Display Displays temp and status codes.
3	Signal Indicator Light
4	Temperature Up 5° Increment control
5	Temperature Down 5° Increment control
6	Power Button
7	Food Probe 1 Button When the food probe is connected, press to read the internal temp of your food. Press again to switch back to grill temp.
8	Food Probe 1 Connection Insert a food probe here and run it up and through the steel swinging door on the left side of the grill.
9	Food Probe 2 Button When the food probe is connected, press to read the internal temp of your food. Press again to switch back to grill temp.
10	Food Probe 2 Connection Insert another food probe here and run it up and through the steel swinging door on the left side of the grill.
11	USB Connection Plug in USB to charge a phone or other device.

### DISPLAY STATUS CODES

CODE	DESCRIPTION
OFF	Grill Is Off
FAn	Fan Mode
Upd	Updated
SUC	Update Successful
FAL	Ignition Failure
NFD	No Food Detected
Fod	Ready to Show Food Temp
SEN	Sensor Failure
PGA	Circuit Board Issue

### Changing between °F/C

If you want to change the controller to °C, simply hold the down arrow button for 4 seconds while the unit shows "off" on the display. To go back to °F, follow the exact same method.

# PREFIRE CHECK

Before you set up your grill, make sure to keep the entire grill a minimum of 36 in. (914.4 mm) from all combustibles. Please read and follow the SAFETY INFO section before starting up your

## 1 RECOMMENDED POSITIONING OF HEAT SHIELD

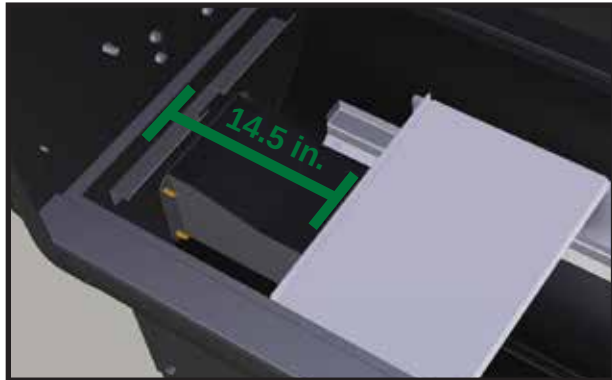

**WARNING** DO NOT over tighten the adjustment rod.

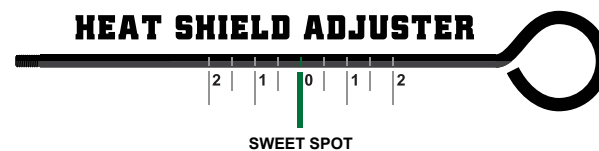

**IMPORTANT**

For a proper centered heat shield position, use the marks on the adjuster handle. The grill wall should align with the 0 mark on the handle, setting the heat shield roughly **14.5 in. (368.3 mm)** from the left inside grill wall.

## 2 REQUIRED INSTALLATION OF GREASE TRAY

**IMPORTANT**

Install the grease tray with the **circle cut-out to the left** and the **half-moon crescent to the right**. This ensures proper travel of grease into your grease trough. For easy clean up, wrap the grease tray in tin foil.

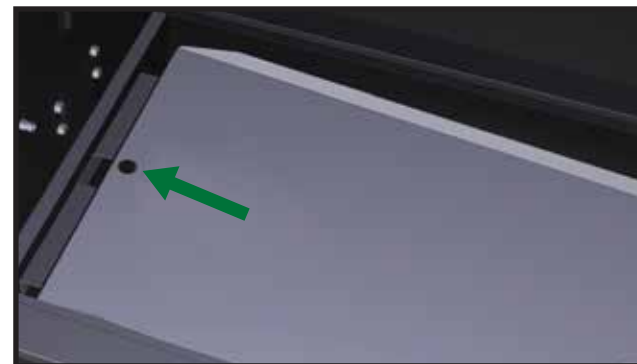

## 3 CLOSE ALL DOORS & LIDS FOR PROPER AIRFLOW

**IMPORTANT**

Always ensure the hopper lid, pellet dump door, and AshVac door are closed while operating the grill.



# OPERATING YOUR GRILL

## PRIMING THE FIREBOX

**IMPORTANT**

You must prime the firebox the first time you start the grill or any time you accidentally let the auger tube run out of pellets.

- 1 Remove grates, grease tray, and heat shield.
- 2 Plug the grill in and press the red POWER button.
- 3 Display will show '0'. Wait until it changes to '1'. and unplug the grill.
- 4 Plug the grill back in and press the red POWER button. .
- 5 Repeat Steps 2-4 until pellets begin to emerge from the end of the auger tube and fall into the firebox.
- 6 Replace grates, grease tray, and heat shield.
- 7 Allow the grill to finish it's 1-2-3 startup cycle and reach 150°F before you set your desired temp.

## SEASONING YOUR GRILL

**IMPORTANT**

**ALWAYS** allow the grill to reach 150°F before adjusting the temperature.

Burn in the grill at 350°F for 30 minutes to remove any residue from the manufacturing process.



## POWERING DOWN YOUR GRILL

- 1 Press the red POWER button. This will shift the grill into "FAN" mode. You will hear the fan kick in and you may hear the auger motor turn intermittently. The grill extinguishes the fire at a rate dependent on the actual temperature when you pressed the power button.
- 2 Unplug the grill from the wall.

## EVERYDAY GRILL START-UP

### ⚠ IMPORTANT

ALWAYS allow the grill to reach 150°F before adjusting the temperature.

- 1 Plug the grill in (if unplugged) and turn it on by pressing the POWER button. Display will show "0" and begin its 1-2-3 start-up cycle.
- 2 Allow your grill to reach 150°F before setting your desired temp.
- 3 Set your temp and get cooking!

## USING YOUR MEAT PROBES



To use this feature, just plug the connector into the receptacle on the front of the controller.

Lift the stainless flap on the left side of the grill and push the probe through the hole. Then, insert the probe into the center of the food you are cooking. Press either the Probe 1 or 2 button to display the temperature of that probe. This process takes a minute or two to stabilize.



To return to the grill temperature display, simply press the probe button again. If you do not have the probe installed in the control panel, then your digital display will read "NFD" (no food) when you press either probe button. The probe is not suitable for reading temperatures above 257°F (150°C).

## UNDERSTANDING YOUR GRILL

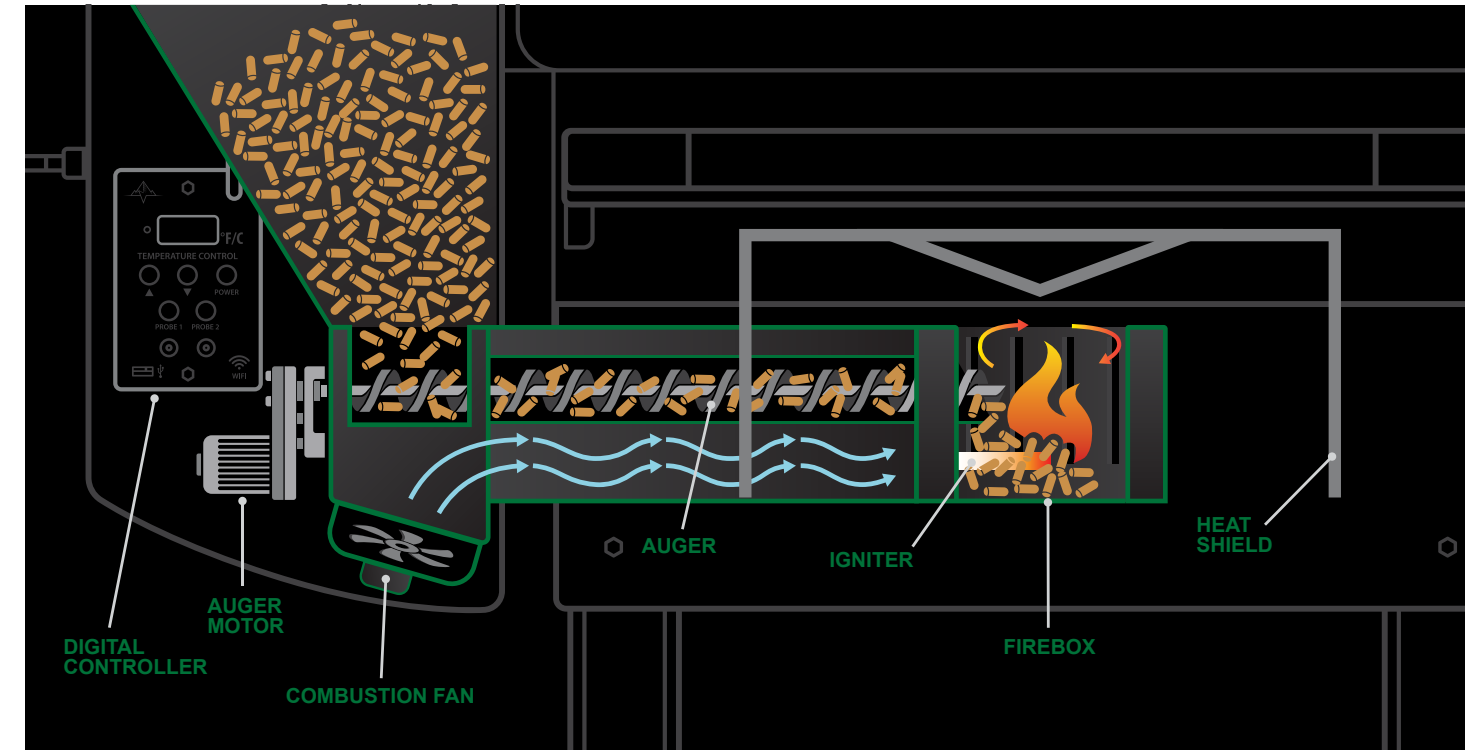

The beauty starts at the core of GMG's 12V Direct Power design. Direct current allows for a micro-adjusted variable speed fan and auger motor that creates more precise temp control, greater fuel economy, and less waste along with increased motor RPM's for quicker pellet feed and faster startups.

The motor turns the auger that feeds pellets into a firebox. There, an igniter in the bottom automatically lights the pellets, and a combustion fan provides oxygen to start the fire.

The Venturi-Style firebox design is lined with vertical vents that create a burn pot cyclone of airflow for maximum heat distribution and complete combustion with minimal waste.

The heat shield that covers the firebox distributes the heat to both sides of the grill, flowing up into the convection style grill chamber. The thermal sensor mounted inside the grill sends data to the on-board computer 10 times every second, and the digital controller adjusts the air and pellet flow to maintain the temperature you set.



## UNDERSTANDING THE STARTUP CYCLE

In case you have an interest in the grills startup functionality, the chart below shows each ignition state and its function in the 1-2-3 startup cycle. The auger run time in stage 0 varies slightly based on ambient temperature.

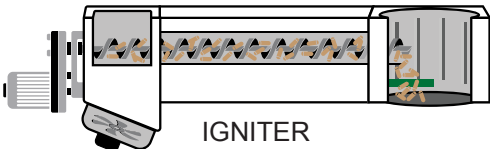
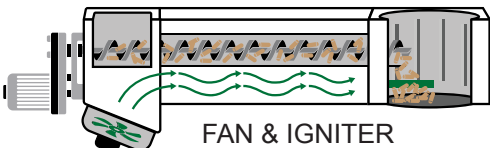
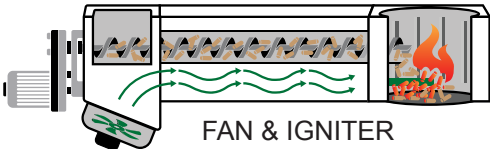
DISPLAY	PARTS WORKING	TIME	FUNCTION
0	 AUGER	55 SECS	Auger turns on and starts pushing pellets into the firebox.
1	 IGNITER	90 SECS	Igniter turns on and starts to heat up the pellets.
2	 FAN & IGNITER	30 SECS	The combustion fan turns on to ignite the pellets.
3	 FAN & IGNITER	30 SECS	The fan and igniter establish proof of fire.

## UNDERSTANDING AIR TEMPERATURE

The PT100 Platinum Sensor sends data to the computer. This “brain” analyzes the data and adjusts the airflow and pellet fuel flow to maintain the set temperature. Many things affect the data gathered by the sensor – opening the lid, wind, grease splatter, humidity, altitude, and gravity (if the grill is not on level ground).

The computer analyzes all the erratic information and averages it over time. Then, it displays the best result as the most accurate representation of the grill’s current temperature. This is why an instantaneous air temperature reading from a third-party product does not provide much useful information.

## THE GRILL WILL MAKE ODD SOUNDS

Huffing sounds are normal. The combustion fan inside the hopper will turn on and off regularly to provide the correct amount of oxygen to the fire to maintain your set temp. The motor that propels the auger is fairly powerful and is thus a bit loud. This is all normal operation.

## MAINTAINING YOUR GRILL



**CLEAN ABOUT EVERY 2 - 3 BAGS**  
80 - 100 LBS  
36 - 45 KGS



Keep the inside of the grill clean using a Shop-Vac. This will take only a few minutes. Remove the interior parts and vacuum any ash and residue out of the base of the grill and the firebox.

### ! BURN CAUTION

- **ALWAYS ENSURE THAT THE GRILL IS COLD AND THE FIRE AND ALL EMBERS ARE OUT BEFORE CLEANING.**
- **ALWAYS** unplug your grill before performing any cleaning, maintenance, and/or electrical component operations.

### ! GREASE FIRE CAUTION

- Clean the grates and grease tray regularly. You can use a wire brush to clean the stainless steel grates. Alternatively, you can use an old camper’s trick of wadding a piece of aluminum foil and rubbing it lightly on the grates to clean them.
- As with any barbecue, the potential for a grease fire exists. To reduce this possibility, regularly clean the grease tray to prevent flammable buildup. An easy way to do this is to line the tray with aluminum foil. Use multiple sheets on the tray and then just peel one off each time you cook.
- **Chimney cap.** Wipe down the underside of the cap regularly to prevent grease drip.
- **Place grill on level ground.** The grill should be kept as level as possible so that the grease flows into the trough and out into the bucket and also to ensure that the sensor reads evenly, as hot air displaced to one side or the other will cause irregular operation.
- **Clean ash out of the firebox periodically.** If ash covers the igniter, the grill may not light. When you clean out the ash from your firepot, it is not necessary to add in more pellets afterwards. The auger will add in the correct amount of pellets in the start-up cycle.
- **Regularly clean the inside of your grill.** Remove grease with hot, soapy water or a grill cleaner. Keep liquids away from the auger tube and the pellets. Liquids will drain through the bottom hole. Alternatively, just turn the grill on at 500°F for an hour or more to bake off most internal residues.
- **Protect your grill.** Use a grill cover as much as possible. Water may be able to get into the hopper in extremely adverse conditions such as high winds or driving sideways rain. Make sure the grill is completely dry before covering.
- **Service?** Answers to most common questions can be found on our website [greenmountaingrills.com/support](http://greenmountaingrills.com/support).

While you will hopefully have no problems, machinery can fail. Fortunately, each part on the grill is modular, so you can easily replace one if necessary.

# WOOD-FIRED 101

- **Smoke Flavor:** You will get more smoke flavor at low temperatures than at high ones. If you wish to infuse a piece of meat with a smoky flavor, cook it at 150°–160°F for an hour or so before you turn up the grill to finish it off.
- **Let Meat Rest.** Beef, pork, poultry, and fish will generally continue to cook after you remove them from the grill as the hot outer part of the meat influences the cooler interior. While it seems possible to eat immediately upon finishing your grilling, that seldom works out as a practical matter. Plan for the internal temperature to rise about 5 degrees after you take it off the grill. Also, resting allows the juices to redistribute more evenly throughout the meat.
- **Spritz!** Always spritz your meat. Pork butts and picnic roasts, steaks, burgers, chops, and ribs will all benefit from regular, generous spritzing. A good staple mixture is apple juice plus 2–3 tablespoons of Worcestershire.
- **Be Creative!** You can cook almost anything on this grill. Try pizza, bread, marinated vegetables, casseroles, and cornbread, as well as steaks, roasts, hams, pork chops or tenderloins, wild game, fish, and poultry. Cook anything outside in this appliance that you would cook in your kitchen oven.
- **Low Temperature Smoking:** For anything you plan to smoke for several hours, we recommend brining it in sugar or salt or both, in the refrigerator for several hours beforehand. This will normally partially cure the meat and should make it safer. We do not recommend smoking poultry below 185°F for health reasons. Cooking it at or above that temperature will still impart a rich, smoky flavor.
- **General Cooking Guide.** If you're new to grilling, this will help you to get started. These are basic guidelines and temps/times can vary depending on the size of what you're cooking, the initial temperature of the food when you put it in, how often you open the lid, and other variables. **ALWAYS COOK MEAT TO A SAFE INTERNAL TEMPERATURE. RECIPES ARE ONLY GUIDELINES.**

FOOD	METHOD	TEMP	TIME
Brats	Grill	450° - 500°F	5 - 10 mins/side
Brisket	Slow-Cook	225° - 240°F	8 - 16 hrs
Burgers	Grill	450° - 500°F	7 - 10 mins/side
Chicken - Pieces	Grill	375° - 425°F	15 - 20 mins/side
Chicken - Whole	Roast	275° - 325°F	1.5 - 2.5 hrs
Fish	Grill	375° - 425°F	7 - 20 mins/side
Hot Dogs	Grill	450° - 500°F	5 - 7 mins/side
Jerky	Smoke	150° - 170°F	4 - 6 hrs
Pizza	Bake	400° - 450°F	14 - 18 mins
Pork Butts/Picnics	Slow-Cook	225° - 240°F	8 - 16 hrs
Ribs	Roast	200° - 250°F	4 - 8 hrs
Roast Beef	Roast	250° - 300°F	1.5 - 3.5 hrs
Salmon - Smoked	Smoke	150° - 175°F	6 - 10 hrs
Steaks	Grill	450° - 500°F	4 - 10 mins/side



## Meathead's AMAZINGRIBS.COM FOOD TEMPERATURE GUIDE

**"By far the leading resource for BBQ and grilling information" Forbes**

For ratings and reviews of more than 150 accurate, inexpensive digital thermometers and BBQ thermostats visit: [AmazingRibs.com/thermometers](http://AmazingRibs.com/thermometers)

<b>Beef, Lamb, Venison, Duck Breasts (Steaks, Chops, Roasts)</b>		<b>USDA Minimum 145°F (63°C)</b>	<b>A</b>
Blue, "Pittsburgh"	110-120°F (43-49°C)	Dark purple, cool, stringy, slippery, slightly juicy	
Rare	120-130°F (49-54°C)	Bright purple to red, warm, tender, juicy	
<b>CHEF TEMP Medium Rare</b>	<b>130-135°F (54-57°C)</b>	<b>Bright red, warm, tender, very juicy</b>	
Medium	135-145°F (57-63°C)	Rich pink, yielding, juicy	
Medium Well	145-155°F (63-68°C)	Tan with slight pink, firm, slightly fibrous, slightly juicy	
Well Done	155°F (68°C) or more	Tan to brown, no pink, chewy, dry	
<b>Pork, Raw Hams, Veal (Steaks, Chops, Roasts)</b>		<b>USDA Minimum 145°F (63°C)</b>	<b>A</b>
Rare	120-130°F (49-54°C)	Pale pink center, warm, tender, slightly juicy	
Medium Rare	130-135°F (54-57°C)	Creamy pink color, tender, very juicy	
<b>CHEF TEMP Medium</b>	<b>135-145°F (57-63°C)</b>	<b>Cream color, some pink, yielding, juicy</b>	
Medium Well	145-155°F (63-68°C)	Cream color, firm, slightly juicy	
Well Done	155°F (68°C) or more	Cream color, tough, dry	
<b>Chicken, Turkey (Whole Or Ground), Including Stuffing</b>		<b>USDA Minimum 165°F (74°C)</b>	<b>A</b>
<b>SV TEMP Medium</b>	<b>150-155°F (66-68°C)</b>	<b>Cream color white meat, pale tan dark meat, tender</b>	
<b>CHEF TEMP Well Done</b>	<b>160°F (71°C)</b>	<b>Cream color white meat, pale tan dark meat</b>	
<b>Ground Meats, Burgers, Sausages, Meat Loaf (Except Poultry)</b>		<b>USDA Minimum 160°F (71°C)</b>	<b>A</b>
<b>SV TEMP Medium</b>	<b>145°F (63°C)</b>		
<b>Grill or pan fry these risky meats to 160°F (71°C) and make them juicy by using a 20 to 30% fat blend</b>			
<b>Fish</b>		<b>USDA Minimum 145°F (63°C)</b>	<b>A</b>
<b>CHEF/SV TEMP Rare to Med. Rare</b>	<b>120-135°F (49-57°C)</b>	<b>Slightly translucent, flaky, tender (tuna: purple to red)</b>	
<b>BBQ/Roasted Ribs, Shoulders, Briskets, Legs, Rumps - USDA Minimum 145°F (63°C)</b>			<b>B</b>
<b>CHEF TEMP Tender, Tugs Apart</b>	<b>203°F (95°C)</b>	<b>High in fat and collagen, best cooked low and slow</b>	

**SOUS VIDE (SV) RULES OF THUMB**  
These times and temps are **starting points** that will produce meats that please. Experiment!

**A - TENDER CUTS**  
**1 - Cook.** Salt, then sous vide for 2-4 hours at the temp at left.  
**2 - Rub.** Remove from bag, pat dry, sprinkle generously with salt-free rub or lightly with salted rub.  
**3 - Finish.** Sear in a hot pan, griddle, or on a grill or smoke at 225°F (107°C). Bring to the temp at left. Glaze or sauce if you wish.

**B - TOUGH CUTS**  
**1 - Cook.** Salt, then sous vide at 145°F (63°C) for about 24 hours.  
**2 - Rub.** Remove from bag, leave wet, sprinkle generously with salt-free rub or lightly with salted rub.  
**3 - Roast or smoke** at 225°F (107°C) until 145-155°F (63-68°C). Glaze or sauce if you wish.

Version 5.0  
Copyright © 2020  
AmazingRibs.com

## GENERAL OPERATING TIPS

- **Setting the Temperature:** Do not push any buttons until the computer finishes the 0-1-2-3 cycles and automatically goes to 150°F (66°C). Once it reaches 150°F (66°C), you can change to your desired setting.
- **Time to Reach Temperature:** It should take about 15 minutes from the time you first turn the grill on until it achieves the temperature you set. Make sure not to adjust the temperature until it reaches 150°F first. Time to heat up will vary based on the ambient air temperature.
- **Temperature Range:** You can set the grill as low as 150°F or as high as 550°F.
- **Grill Ready:** Wait until the grill heats up before cooking. Aside from the soot contained in earlier smokes, the grill will not cook evenly until it gets hot, just as with a charcoal or gas grill. A slowly blinking light on the digital control panel indicates that the grill has achieved the target temperature, while no light means the grill is still heating or cooling.
- **Heat Distribution:** If you are experiencing larger left-to-right temperature discrepancies, the heat shield can be moved along the belly of the grill left or right to assist with these differences. See our recommended heat shield positioning in the assembly guide. A centered heat shield placement is best for even heat distribution.

The grill temperature will climb fairly rapidly. The temperature, however, falls much more slowly. This is because the fire must be kept going at all costs, which results in a fairly slow fall in inside temperature. Here, too, you can speed the process by opening the lid to let excess heat escape.



NEVER INCREASE TEMPERATURE UNTIL IT REACHES THE 150°F MARK.

- **The grill needs to make P.O.F** (Proof of Fire) which is 5 degrees above ambient temperature. At that point the board will turn the igniter off and start the auger motor to guide the grill up to 150°F. It is imperative for the grill lid to be closed for this to happen.

ONCE THE GRILL HAS REACHED 150°F, YOU MAY INCREASE TO YOUR DESIRED TEMPERATURE.

- If there is not a 5° increase within 20 minutes the grill will display FAL. At this point see page 22 of the troubleshooting section.
- **Temperature Variances:** The temperature on the digital readout reflects the temperature at the sensor located in the top center of the grill cavity. If you use supplemental thermometers to read the temperature, they may vary from the grill's data depending on where you locate yours.
- **Weather:** ALWAYS keep your grill out of rain and snow when not in use. A grill cover will clearly help the situation, but the garage seems more fool-proof.
- **Keep the Lid Closed When Cooking.** The grill cooks with convection heat, so an open lid only dissipates heat into the atmosphere. "If you're lookin', you're not cookin'."
- **Pellet Checking:** Be sure to keep pellets in the hopper! Check your hopper occasionally so that your grill does not go out in the middle of cooking your meal.
- **Pellet Storage:** Store your pellets in a cool, dry place.
- **Bypass Mode for Hot Restarts:** Occasionally, you may experience a power outage while the grill is in use, or someone accidentally turns the grill off, or you undercook something and want to resume cooking for a little longer.

ONLY use this procedure if power is lost and a fire is still in the grill or for testing parts.

Use this method if you still have some fire left in the firebox, which is usually no longer than about 6–7 minutes later. If you have run the fan mode for more than about 3–4 minutes, this will not work.

If necessary, make sure the grill is plugged in first. When the digital readout displays off, press the red power button to turn the grill back on. Once the display reads "0" hold the power button for approximately 7 seconds, or until the digital readout displays a temperature. Now adjust the temperature to your desired setting.

- **Powering Down:** Simply press the red power button and your grill will automatically go into fan mode. Allow fan mode to complete which takes about 15 mins. Once the fan mode is complete the display will read "oFF." You can leave the grill plugged in for easier power up of your next cook or unplug it if you prefer.

## TROUBLESHOOTING

### ! Grill doesn't turn on when you press the power button.

- ✓ Check to make sure the power cord is plugged in. Make sure you have turned on the ON-OFF switch located underneath the back side of the hopper.

Check the circuit breaker and/or GFCI on the circuit the adapter is plugged into. Plug a small appliance into the same outlet to see if you have electricity.

### ! Grill doesn't come up to temperature.

- ✓ **If grill remains at ambient temperature...**

Check the firebox to see if it has overflowed with pellets. If it has, clean it out and start over. **Before you restart, you must make certain that the firebox is clean.** This overfill can result from turning the grill off without using the fan mode or from charging the firebox when it does not need to be charged. Reread the section on "Priming the Firebox" on pg. 12 to understand that. You only need to prime the firebox the first time you use the grill or on any subsequent occasions when it runs out of pellets and the auger runs until empty.

- ✓ **If the grill lights, but does not reach the set temperature...**

Check the combustion fan to ensure it spins freely and there is no damage to the blades.

Ensure the heat shield is properly installed.

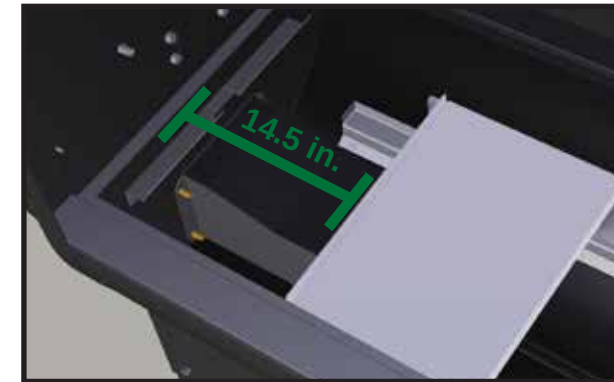

Improper shield placement will result in issues coming to temperature. When using the heat shield adjustment rod, a centered heat shield should be positioned approximately at the "0" mark on the rod, setting the heat shield roughly **14.5 in. (368.3 mm)** from the left inside grill wall. The depth to which the rod is threaded into the receiving nut varies, so some experimenting might be needed to find the perfectly adjusted center point on your rod.

Ensure the grease tray is installed correctly.

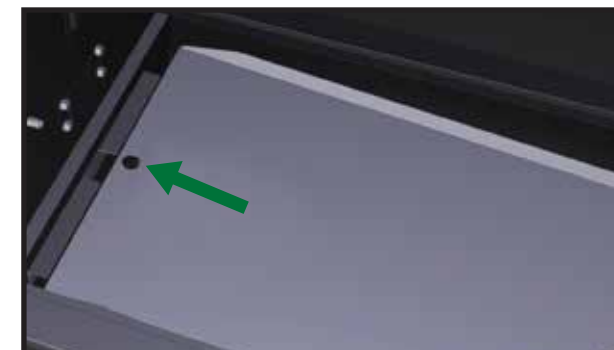

Install the grease tray with the **circle cut-out to the left** and the **half-moon crescent to the right**. This ensures proper travel of grease into your grease trough. For easy clean up, wrap the grease tray in tin foil.



### **Erratic temperature.**



If the digital display reads “SEN” or shows rapid fluctuation in temperature (faster than the grill could realistically increase/decrease its internal temperature). Contact us at support@greenmountaingrills.com

Otherwise, check to make sure you do not have aluminum foil on the grease tray that is blocking the hole in it on the left side. It is okay to wrap your tray in foil. However it must be wrapped tightly to the metal. The hole on the left side as well as the half-moon cutout on the right side must be punched out of the foil to ensure proper airflow.

A simple way to check the thermal sensor is to look at the initial temperature reading the grill gives after the 0-1-2-3 start-up process. This temperature should be close to the ambient air temperature since the grill has not yet had a chance to heat up.

Improper heat shield placement may result in issues getting up to your set temperature. When using the heat shield adjustment rod, a centered heat shield should be positioned approximately at the “0” mark on the rod. The depth to which the rod is threaded into the receiving nut varies, so some experimenting might be needed to find the perfectly adjusted “0” point on your rod.

Ensure the grease tray is installed correctly. See the previous page for proper installation.



### **Smoke is coming out of the hopper.**



Make sure there are pellets in the hopper.

Make sure your burn pot is empty of ash and pellets.

Make sure the hopper lid stays closed when you have the grill on. Simply lock it shut.

You can test this by running 2 sheets of tin foil over your hopper then closing the lid down on top of the foil to make a temporary seal, hopefully preventing smoke from traveling through your hopper.

Ensure the combustion fan spins freely and is not damaged.

Ensure the pellet dump door is closed tight.



### **No pellets in the firebox.**



Assuming that you’ve charged the firebox so that there are pellets in the auger tube, turn the grill on and press the power button to send the control to cycle 0. Examine the auger bit through the firebox to see if it’s turning.

If it is and there aren’t any pellets coming through, they are bridged up over the auger’s intake. Turn the grill off, sift the pellets around inside the hopper, and put the grill back into cycle 0. Wait until the pellets emerge into the firebox. It may take up to 4 full cycle 0’s to get pellets all the way through the auger tube. Once they emerge, turn the grill off and start it again all the way through the 0-1-2-3 cycles to fire it up.

It may take more if the auger is not turning. Listen for the auger motor. If the auger motor is engaged and the auger bit is not turning, then there is a broken linkage between the motor and the auger shaft. Contact technical support at support@greenmountaingrills.com.



### **Uneven heating.**



Uneven heat can be corrected by making small adjustments to your heat shield placement. Try sliding the shield toward the hot side in ¼ inch increments while taking note of the temperature changes. Using the Heat shield adjustment rod, a centered heat shield should be positioned approximately at the “0” mark on the rod. The depth to which the rod is threaded into the receiving nut varies, so some experimenting might be needed to find the perfectly adjusted “0” point on your rod. Once you find the best heat shield placement, we encourage you to mark that distance on the heat shield adjustment rod. That way, you can subsequently repeat the positioning whenever the grill is relocated or the burn pot is cleared internally.

### **Grill didn’t light (FAL message).**

There may be too much ash in the firebox. Wait until it cools off, and clean out the ash. Alternatively, pellets may have overfilled the firebox. Never turn the grill off and on repeatedly as this will overfill the firebox with pellets. Each time the grill displays “0” on start-up, it feeds a full load of pellets into the firebox. The igniter won’t light the pellets unless air can flow freely through the combustion chamber.

The combustion fan may not have been operating. Check to make sure that the fan blades turn freely and the fan runs on cycles 2 and 3 of the 0-1-2-3 sequence.

The auger might not have turned pellets into the firebox. Refer to “No pellets in the firebox” on the last page.

If there isn’t any ash or pellet buildup, the fan works properly, and fresh pellets are feeding in, your igniter is most likely out and the grill will require a replacement igniter.

\*The grill can be manually lit if the igniter is out. Charge the burn pot with a handful of pellets, and light them with a propane torch. Once the pellets are able to maintain a flame by themselves, plug the grill in so it displays “off.” Hold the “power” button for 10 seconds. The grill will initially display “0” but then skip to a temperature reading while turning on the fan and auger. Let the grill come to 150 then select your grilling temperature like normal.

### **Auger is jamming.**

Turn the grill into cycle 0 by pressing the “power” button (first stage of the normal start-up procedure), and listen for the auger motor. If the motor engages, look inside your firebox toward the end of the auger bit to determine if the auger is spinning. If the auger is spinning but you don’t have pellets feeding into the burn pot, you have pellets bridged up over the intake of the auger tube. Turn the grill off, sift the pellets around inside the hopper, and put the grill back into cycle 0. Wait until the pellets emerge into the firebox. It may take up to 2 full cycle 0’s to get pellets all the way through the auger tube.

If you have determined that your auger does not turn when the auger motor is engaged, you can try to work the affected pellets through the auger tube to clear out the jam. Remove the grease tray and heat shield from the body of the grill. Remove all the pellets from the hopper and the firebox.

Once the auger tube is clear, you will need to refill it with fresh pellets by running cycle 0 a few more times after the hopper has been filled. Once you see fresh pellets coming out, turn off the grill and start it up again through the entire 0-1-2-3 process with the heat shield and grease tray installed.





### Combustion fan doesn't seem to be working properly.



There's no need for concern if your fan is not blowing at a constant speed. It will run at many RPMs in order to maintain the most stable temperature.

The fan should run continuously from cycle 2 on start-up until the grill completes the fan mode.

First, unplug the grill. Then, using your finger, flick the fan to make sure it spins freely and does not appear to have any visible damage. If there is any damage to the blades, your grill will require a new combustion fan.

Check the wires leading to the combustion fan to make sure those connections are secure and undamaged.



### Temperature



Temperature is an immediate measurement. If you open the lid for an extended period of time, the unit will drop in temperature and feed accordingly to compensate. Depending on the time the lid is open, the unit will overshoot set temperature after the lid is closed. The temperature will level out over time. This is normal operation.



### Grease Management



We recommend using foil over the grease tray leaving air flow open from both the front and back around the grease tray. It is also imperative to not cover the hole in the grease tray if covering with foil. Grease should always flow from left to right into the right side trough and into the bucket on the outside of the unit.

## CUSTOMER SUPPORT



WE'RE COMMITTED TO MAINTAINING THE BEST CUSTOMER SERVICE IN THE INDUSTRY

For troubleshooting, service parts, & general grill support check out our support page:



SCAN ME



[GREENMOUNTAINGRILLS.COM/SUPPORT](https://greenmountaingrills.com/support)

Have a question?



Contact us at:  
[support@greenmountaingrills.com](mailto:support@greenmountaingrills.com)

Need help with assembly & setup?

SCAN FOR BILT 3D INSTRUCTIONS



POWERED BY BILT INTELLIGENT INSTRUCTIONS\*



This LIMITED WARRANTY covers defects in workmanship and materials for a period of three (3) years from the date of first retail purchase. During the warranty period, GMG Products, LLC (dba Green Mountain Grills) will replace or repair, at its sole option, any defective Green Mountain grill returned to us, or to one of our dealers, by its original purchaser. Any claims under this warranty must be received by the expiration of the warranty period.

This warranty does not cover problems that result from abuse, accident, misuse, or problems with electrical power. It does not cover cosmetic elements and components, such as paint and other finishes. It does not cover uses not in accordance with the instruction manual. It does not cover commercial use of the product. It specifically excludes products for which Green Mountain Grills has not received payment.

THIS WARRANTY GIVES YOU SPECIFIC LEGAL RIGHTS WHICH MAY VARY FROM STATE TO STATE (PROVINCE TO PROVINCE IN CANADA). GREEN MOUNTAIN GRILLS RESPONSIBILITY FOR DEFECTS IN MATERIAL AND WORKMANSHIP SHALL BE LIMITED TO REPAIR AND/OR REPLACEMENT AS SET FORTH IN THIS WARRANTY. ALL EXPRESS AND IMPLIED WARRANTIES, INCLUDING, BUT NOT LIMITED TO, ANY IMPLIED WARRANTIES AND WARRANTIES OF MERCHANTABILITY OR FITNESS FOR A PARTICULAR PURPOSE ARE DISCLAIMED. NO OTHER WARRANTIES ARE PROVIDED.

IN NO EVENT WILL GMG PRODUCTS, LLC (dba GREEN MOUNTAIN GRILLS) HAVE ANY LIABILITY FOR SPECIAL, INCIDENTAL OR CONSEQUENTIAL DAMAGES, WHETHER TO THE ORIGINAL PURCHASER OR WITH RESPECT TO ANY THIRD-PARTY CLAIMS FOR DAMAGES AGAINST THE RETAIL PURCHASER OF THIS PRODUCT. SOME STATES (PROVINCES IN CANADA) DO NOT ALLOW THE EXCLUSION OR LIMITATION OF INCIDENTAL OR CONSEQUENTIAL DAMAGES, SO THIS MAY NOT APPLY TO YOU.

To exercise your rights under this warranty, contact the dealer from whom you purchased it, or call us at 530-347-9167.

HOPPER LID MUST BE CLOSED WHEN THE GRILL IS ON

REGISTER YOUR WARRANTY HERE:  
[greenmountaingrills.com/warranty-registration](https://greenmountaingrills.com/warranty-registration)